

Technical data sheet

Product features



Chilled display unit GN 3-1/1 drop-in, opening to the sides

Model	SAP Code	00012074
--------------	-----------------	----------



- Buffet type: PLATINUM - dynamically cooled showcase
- Device properties: Chilled
- Number of GN / EN: 3
- GN / EN size in device: GN 1/1
- GN device depth: 200
- Minimum device temperature [°C]: 4
- Maximum device temperature [°C]: 8
- Opening of device: Sliding to the sides

SAP Code	00012074	Loading	230 V / 1N - 50 Hz
Net Width [mm]	1139	Number of GN / EN	3
Net Depth [mm]	760	GN / EN size in device	GN 1/1
Net Height [mm]	1210	GN device depth	200
Net Weight [kg]	116.00	Minimum device temperature [°C]	4
Power electric [kW]	0.247	Maximum device temperature [°C]	8

Technical data sheet

Technical drawing



Chilled display unit GN 3-1/1 drop-in, opening to the sides

Model

SAP Code

00012074

A= ELECTRICAL CONNECTION
 D= WATER DISCHARGE Ø16
 E= GAS CONNECTION Ø8 Ø10
 F= WATER BOX

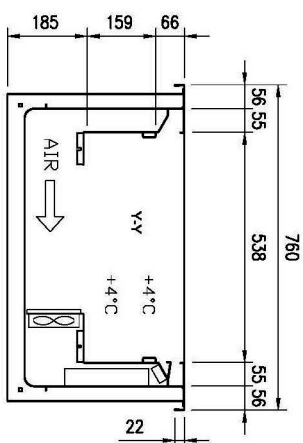
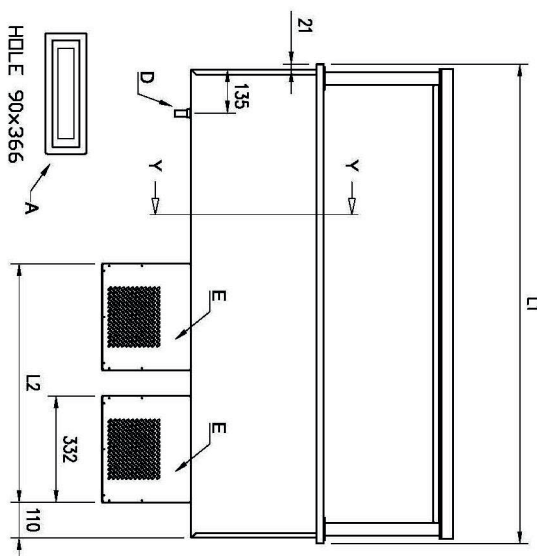
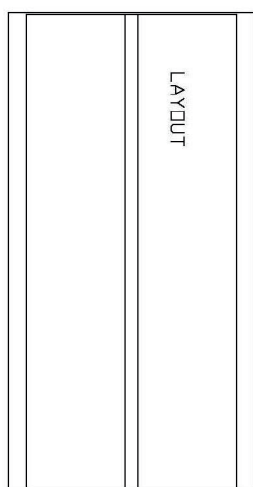

GN	L1	L2	HOLE
4/1	1494	744	1460x726
5/1	1819	744	1785x726
6/1	2144	1069	2110x726

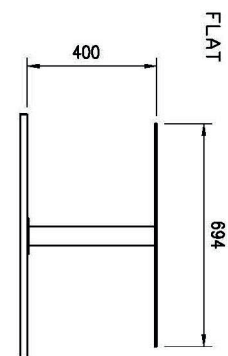
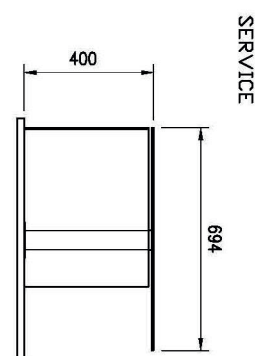
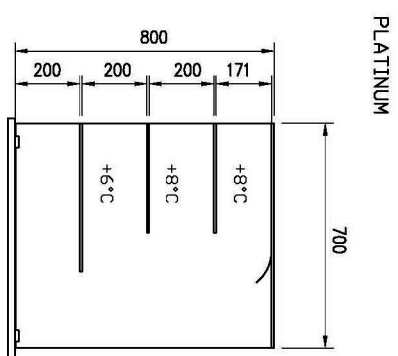
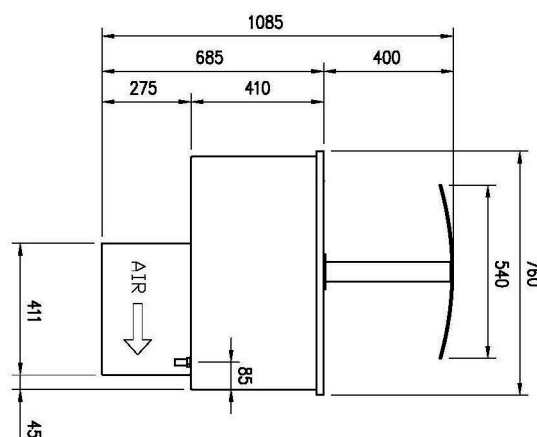

Technical data sheet

Product benefits



Chilled display unit GN 3-1/1 drop-in, opening to the sides

Model

SAP Code

00012074

1

Dynamic cooling

constant temperature in all places of the refrigerated space

- greater hygienic safety of chilled food

2

LED lighting

minimal energy consumption

- economical lighting
- attractive appearance

3

Surface height regulation

a large range of the height of the bottom surface of the display case

- greater variability of product storage
- space saving

4

Back attendant

service and delivery on different sides

- possibility to refill products at any time during operation

5

Built-in

the possibility to plant in a dispensing block design

- unified design of the dispensing line
- a luxurious look that customers appreciate

Technical data sheet

Technical parameters



Chilled display unit GN 3-1/1 drop-in, opening to the sides

Model

SAP Code

00012074

1. SAP Code:

00012074

2. Net Width [mm]:

1139

3. Net Depth [mm]:

760

4. Net Height [mm]:

1210

5. Net Weight [kg]:

116.00

6. Gross Width [mm]:

1233

7. Gross depth [mm]:

860

8. Gross Height [mm]:

1830

9. Gross Weight [kg]:

174.10

10. Device type:

Electric unit

11. Buffet type:

PLATINUM - dynamically cooled showcase

12. Device properties:

Chilled

13. Exterior color of the device:

Stainless steel

14. Power electric [kW]:

0.247

15. Loading:

230 V / 1N - 50 Hz

16. Number of GN / EN:

3

17. GN / EN size in device:

GN 1/1

18. GN device depth:

200

19. Minimum device temperature [°C]:

4

20. Maximum device temperature [°C]:

8

21. Opening of device:

Sliding to the sides

22. Interior lighting:

No